



Digital pressure gauges

Reference types E2 / D2 / C2



Table of contents	page
0 About this operating manual.....	31
1 Device description	32
1.1 Delivery, unpacking and accessories	33
1.2 Intended use.....	33
1.3 Exclusion of liability	34
2 Safety instructions.....	35
3 Construction, function and measuring process	36
4 Connection and battery replacement	38
4.1 Connection.....	38
4.2 Battery replacement.....	39
5 Commissioning, switching on and off	40
5.1 Commissioning.....	40
5.2 Switching on and off.....	40
6 Measuring mode and operation of the Functions.....	41
6.1 Measuring mode	41
6.1.1 Menu for device settings.....	42
6.2 Operation of the functions.....	43
6.3 Functions in the menu for device settings	45
7 Maintenance and cleaning, storage and transport.....	47
7.1 Return shipment to the manufacturer	48
8 Disassembly and disposal.....	49
9 Technical data	50
10 EC Declaration of Conformity.....	53

Copyright notice:

The reproduction, distribution and utilization of this operating manual as well as the communication of its contents to others without express authorization is prohibited. Offenders will be held liable for the payment of damages. All rights reserved in the event of the grant of a patent, utility model or design.

0 About this operating manual

- The operating manual is aimed at specialists and semi-skilled personnel.
- Before each step, read through the relevant advice carefully and keep to the specified order.
- Thoroughly read and understand the information in the section "Safety instructions".

If you have any problems or questions, please contact your supplier or contact us directly at:



Dr. Siebert & Kühn GmbH & Co. KG
 Struthweg 7-9 • D - 34260 Kaufungen
 ☎ +49 5605 803-0 • 📠 +49 5605 803-555
 info@sika.net • www.sika.net

Hazard signs and other symbols used:



WARNING! / CAUTION! Risk of injury!

This sign indicates dangers that cause personal injuries that can lead to health defects or cause considerable damage to property.



CAUTION! Risk of injury in the case of excessive pressure!

This sign indicates dangers which could arise from excessive pressure in a piece of equipment.



CAUTION! Material damage!

This sign indicates actions which could lead to possible damage to material or environmental damage.



ADHERE TO OPERATING MANUAL!



NOTICE!

This symbol indicates important notices, tips or information.



NO DOMESTIC WASTE!

The device must not be disposed of together with domestic waste.



Pay attention to and comply with information that is marked with this symbol.



Follow the specified instructions and steps. Adhere to the given order.



Check the specified points or notices.



Reference to another section, document or source.



Item.

1 Device description

The references E2 / D2 / C2 are digital manometers with actual value and MIN/MAX displays. They are used to measure stationary and mobile pressures.

They have a rugged housing made of cast zinc with a rubber protection cap. The electronics unit, the 4 ½ -digit LCD digital display, the control panel and the replaceable batteries are housed inside the device.

The references have accuracies of $\pm 0.5\%$ Type E2, $\pm 0.1\%$ Type D2 and $\pm 0.05\%$ Type C2, relative to the corresponding full-scale reading (FS).

Used as a pressure reference, they provide an easy way of checking, adjusting and calibrating other items of pressure measuring equipment.

Versions:

The references E2 / D2 / C2 differ in terms of their accuracy and are available for the following pressure ranges.

Accuracy (FS)		E2 0.5 %	D2 0.1 %	C2 0.05 %
Pressure range	Resolution			
-1...3 bar	1 mbar	✓	✓	
-1...5 bar	1 mbar	✓	✓	
-1...10 bar	1 mbar	✓	✓	✓
-1...20 bar	1 mbar	✓	✓	✓
-1...40 bar	10 mbar	✓	✓	✓
-1...60 bar	10 mbar	✓	✓	✓
0...100 bar	10 mbar	✓	✓	✓
0...160 bar	10 mbar	✓	✓	✓
0...250 bar	100 mbar	✓	✓	✓
0...400 bar	100 mbar	✓	✓	✓
0...700 bar	100 mbar	✓	✓	✓
0...1000 bar	100 mbar	✓	✓	✓

Type plate:

The type plate is located on the back of the E2 / D2 / C2.

It contains the most important data.

1.1 Delivery, unpacking and accessories

All units have been carefully checked for their operational reliability before shipment.

- Immediately after receipt, please check the outer packaging for damages or any signs of improper handling.
- Report any possible damages to the forwarder and your responsible sales representative. In such a case, state a description of the defect, the type and the serial number of the device.
Report any in-transit damage immediately. Damage reported at a later date shall not be recognized.

Unpacking:

- ↪ Carefully unpack the unit to prevent any damage.
- ↪ Check the completeness of the delivery based on the delivery note.

Scope of delivery:

- 1x E2 / D2 / C2 according to the order data.
- 1x Operating manual.
- Packaging or transport protection (if applicable).



IMPORTANT!



- ↪ Use the type plate to check if the delivered unit corresponds to your order.
- ↪ In particular, for devices with electrical components, check to see if the correct power supply voltage is specified.

1.2 Intended use

The digital manometer E2 / D2 / C2 is intended solely for inspecting, adjusting and calibrating pressure measuring equipment.

Do not use the reference E2 / D2 / C2 outside the specifications and do not disregard the operating instructions.

WARNING! No safety component!



The reference E2 / D2 / C2 is not a safety component in accordance with Directive 2006/42/EC (Machine Directive).

- ↪ Never use the reference E2 / D2 / C2 as a safety component.

The operational safety of the device supplied is only guaranteed by intended use. The specified limits (→ § 9 "Technical data") may under no circumstances be exceeded. This applies especially to the compliance with the permissible full-scale reading and the permissible temperature range.



DANGER! Risk of injury or material damage in the case of excessive pressure!!

Exceeding the maximum overload values can lead to material failure of the digital manometer. At the same time, that can cause serious harm to health.

☞ Make sure that the overload values are never exceeded.

Before ordering and installation, check that the reference is suitable for your applications.

1.3 Exclusion of liability

We accept no liability for any damage or malfunctions resulting from incorrect installation, in-appropriate use of the device or failure to follow the instructions in this operating manual.

2 Safety instructions



Before you install the E2 / D2 / C2, read through this operating manual carefully. If the instructions contained within it are not followed, in particular the safety guidelines, this could result in danger for people, environment, device and the system it is connected to.

The E2 / D2 / C2 correspond to the state-of-the-art technology. This concerns the accuracy, the operating mode and the safe operation of the device.

In order to guarantee that the device operates safely, the operator must act competently and be conscious of safety issues.

SIKA provides support for the use of its products either personally or via relevant literature. The customer verifies that our product is fit for purpose based on our technical information. The customer performs customer- and application-specific tests to ensure that the product is suitable for the intended use. With this verification all hazards and risks are transferred to our customers; our warranty is not valid.

Qualified personnel:

- ⚠ The personnel who are charged for the installation, operation and maintenance of the E2 / D2 / C2 must hold a relevant qualification. This can be based on training or relevant tuition.
The personnel must be aware of this operating manual and have access to it at all times.
- ⚠ The electrical connection should only be carried out by a fully qualified electrician.

General safety instructions:

- ⚠ In all work, the existing national regulations for accident prevention and safety in the workplace must be complied with. Any internal regulations of the operator must also be complied with, even if these are not mentioned in this manual.
- ⚠ Degree of protection according to EN 60529:
Ensure that the ambient conditions at the site of use does not exceed the requirements for the stated protection rating (→ § 9 "Technical data").
- ⚠ Only use the E2 / D2 / C2 if it is in perfect condition. Damaged or faulty devices must be checked without delay and, if necessary, replaced.
- ⚠ When fitting, connecting and removing the E2 / D2 / C2 use only suitable appropriate tools.
- ⚠ Do not remove or obliterate type plates or other markings on the device, as otherwise the warranty is rendered null and void.

Special safety instructions:

Warnings that are specifically relevant to individual operating procedures or activities can be found at the beginning of the relevant sections of this operating manual.

3 Construction, function and measuring process

For inspecting, adjusting or calibrating, the digital manometer E2 / D2 / C2 must be connected to a pressure generator and the pressure measuring equipment to be tested.

The section "Measurement process" uses examples to describe the calibration process using a P40.2 pneumatic hand pump as a pressure generator and a mechanical manometer as the unit under test.

Components:

The most important components of the E2 / D2 / C2 are

- ① Cast zinc housing with rubber protection cap.
- ② LCD display with backlight.
- ③ Control panel with buttons.
- ④ G $\frac{1}{4}$ " pressure connection shanks.
- ⑤ Type plate.
- ⑥ Rear cover with fastening screws.
- ⑦ Gasket in the pressure port.



Display and control panel:

- ① Measured value display.
- ② Control panel with buttons.
- ③ Bar graph display with drag indicator function.
- ④ Unit display.
- ⑤ Status line.



The digital pressure gauge E2 / D2 / C2 has a LCD display with additional elements and a graphic bar graph display.

The measured values are displayed as numbers in the 4 $\frac{1}{2}$ -digit display ①. The selected measurement unit ④ (bar, PSI, mbar, kPa, MPa, kg/cm 2 , mH $_2$ O, inchH $_2$ O) is displayed next to the measurement value.

The bar graph display ③ represents the pressure range of 0 to 100% in graphic blocks. The drag indicator function shows pressure peaks with a single line.

In the status bar ⑤, the battery symbol  indicates the current battery level. Next to that, depending on the default, the MIN-, MAX- or FS value is shown.

The measuring mode (→ § 6.1) and the menu for device settings (→ § 6.1.1) are operated using the four buttons on the control panel ②.

Function of the reference:

Signals from the pressure measurement cells are recorded at a sampling rate of 10 ms (100 measurements/s), converted into pressure values and displayed. The high sampling rate means that dynamic pressure peaks can also be measured. These are written to the MIN/MAX memory, which is continuously updated.

The reference E2 / D2 / C2 supports daily pressure measurements with practical functions such as MIN/MAX display, display filter, zero function, pressure unit adaptation, illumination, battery level display and a programmable Auto-Off function.

Measurement process:

Connect the reference E2 / D2 / C2 ① and the test unit ③ to the hand pump ②.

For the measurement process, it is important that the same pressure is applied to the reference and to the test unit. That is ensured with the P40.2 pneumatic hand pump.

The E2 / D2 / C2 reference is screwed via the pressure connection shanks ⑦ directly to the hand pump. Connect the test unit with a flexible pressure hose ④.

Then use the hand pump to build up the pressure and set the required testing points.

The measurements and the additional information are shown in the LCD display ⑤ of the reference E2 / D2 / C2.

Control and set the functions with the control panel membrane buttons ⑥.

As soon as the pressure has stabilised on the pressure points, the current measurements are read.

The measurements of the test unit and the reference are logged and evaluated.



Example measurement setup with hand pump .

4 Connection and battery replacement

The digital manometer E2 / D2 / C2 has a G $\frac{1}{4}$ " (BSPP) male thread and is supplied with batteries fitted. The device is ready for operation after it is switched on (→ § 5.2).

WARNING! Material damage and risk of injury!

Comply with the nominal pressure specifications of the measurement port and the adapter!



The connection (AF 27) is approved up to a nominal pressure of 1,000 bar.

- ↪ Observe the nominal pressure specifications of the integrated measurement ports and the specified safety factors.
- ↪ Comply with the instructions in these operating manual!
In particular, improper installation of the manometer and the related adapter can lead to the manometer tearing off.

Please observe the following instructions when using the E2 / D2 / C2:

- Only authorised personnel are permitted to operate and control the device.
- The deployment location should be sufficiently bright and easy to operate.
- Take appropriate precautions to protect the device from damage.
- Pay attention to adequate protection against weather. Observe the degree of protection according to EN 60529 (→ § 9 "Technical data").

4.1 Connection

- ↪ 1. Prepare the measurement setup for connection to the G $\frac{1}{4}$ " pressure connection shank.
- ⚠ Only use adapters with corresponding nominal pressure specifications!
- ↪ 2. Make sure that the gasket is correctly seated in the pressure connection shank.
- ↪ 3. Carefully turn the reference by hand into the measurement setup thread.
- ↪ 4. Tighten the pressure connection shank with an open-end wrench (AF 27).
- ⚠ You must assemble with a torque of 25 Nm.
- ↪ 5. Align the reference for your application.



IMPORTANT! Check for free turning.

The housing of the E2 / D2 / C2 can be rotated on the pressure connection shank. During direct assembly, make sure that no attachments interfere with the free turning.

4.2 Battery replacement

The battery capacity is continuously monitored by the electronics of the E2 / D2 / C2 and is indicated by the number of bars (0...5 bars) in the battery symbol.



The batteries should be replaced when no bar is visible and the battery symbol flashes. The E2 / D2 / C2 is still completely functional.



The batteries must be replaced when the additional message "Lo bAtt" appears. The E2 / D2 / C2 is no longer operational.

CAUTION! Observe the battery type and polarity!



Damage can be caused if a different type of batteries is used or the batteries are incorrectly inserted during replacement.

- ↪ Use only fresh batteries of the same type (LR6 - AA) when replacing.
- ↪ Pay attention to correct polarity when inserting.

Comply with the following instructions when replacing the batteries:

- ↪ 1. Switch off the device.
- ↪ 2. Press the top section of the rubber protection cap backwards over the housing and remove it in the downward direction over the pressure connection shank.
- ↪ 3. Open the housing:
Remove the screws from the rear cover.
Set the rear cover and the screws aside.
- ↪ 4. Remove the old batteries.
- ⚠ No domestic waste!
The batteries must be disposed of.
- ↪ 5. Insert the new batteries.
!!! Pay attention to the POLARITY !!!
- ↪ 6. Check the seating of the gasket in the rear cover and watch out for signs of damage.
- ↪ 7. Carefully attach the rear cover to the housing with the screws.
- ↪ 8. Re-tighten the rear cover screws.
- ↪ 9. Pull the rubber protection cap back over the housing.
While doing so, make sure the recess of the rubber bulge on the front is underneath the button panel.



5 Commissioning, switching on and off

The digital manometer E2 / D2 / C2 is supplied with batteries fitted. The device is ready for operation after it is switched on (→ § 5.2).

5.1 Commissioning

Before switching on the E2 / D2 / C2 for first time and when making changes in the measurement setup, follow the instructions below.

Check if

- all test setup components are connected to each other.
- all connections were made properly and are pressure-proof.

5.2 Switching on and off

Switch the E2 / D2 / C2 on and off with the **ON/OFF** button.

Switching on:

The device first performs a self-test and is subsequently in the measured value display.

- ↶ Briefly press the **ON/OFF** button.
 - All segments of the digital display will appear briefly.
 - After that, the pressure range (FS) of the device and the most recently used pressure unit are displayed.
 - The current setting of the automatic shut-off follows (P_0):
 - "on" = activated; "off" = deactivated.
 - Finally, the serial number and the installed software version of the device are displayed.
 - The device is subsequently ready and displays the current measurement values.

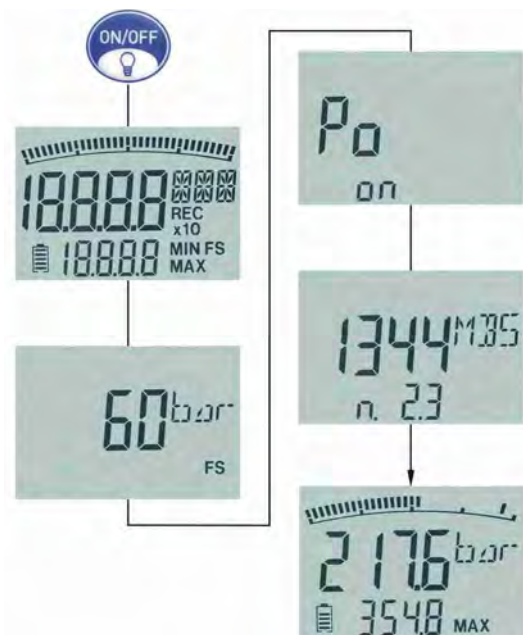

Switching off:

- ↶ Briefly press the **ON/OFF** button.
 - The device is switched off and the display is blank.

Automatic shut-off:

With activated " P_0 " function (on), the device switches off after 5 min (→ p. 45).

6 Measuring mode and operation of the Functions

After switching on and completion of the start-up procedure, the E2 / D2 / C2 enters measuring mode. The current reading is displayed.

6.1 Measuring mode

The following illustration shows the operation and functions in the measuring mode:

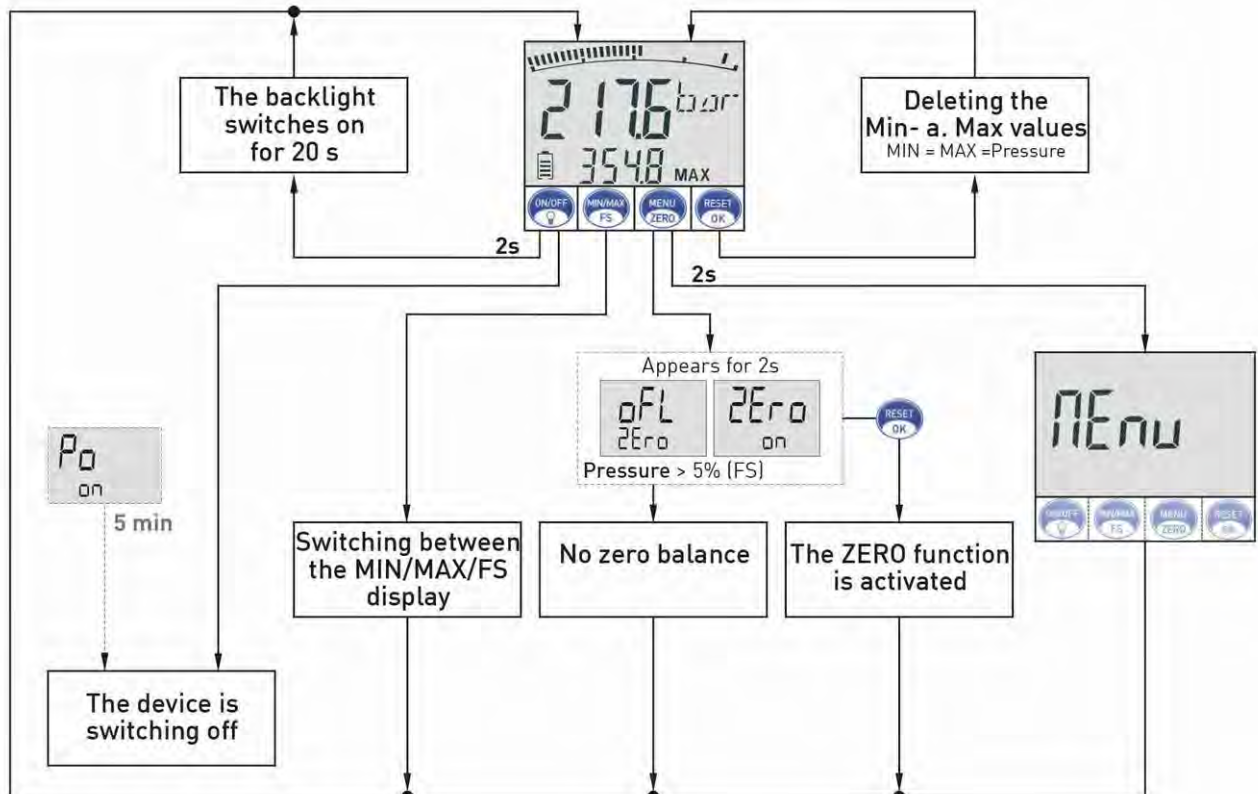

In measuring mode, you can activate the various functions (→ § 6.2) or call the Menu for device settings (→ § 6.1.1) for the E2 / D2 / C2 device.



ON/OFF/⚙ button:

The **ON/OFF** button is used for switching the device on and off (→ § 5.2).

The **⚙** button switches the backlight on for 20 s (→ § 6.2).



MIN/MAX/FS button:

Use the **MIN/MAX/FS** button to change the status bar between the minimum value (MIN), maximum value (MAX) and the pressure range (FS) (→ § 6.2).

The selection is displayed the next time the device is switched on.



MENU/ZERO button:

The **MENU** button is used to call the menu for the device settings.

Use the **ZERO** button to perform a zero balance.



RESET/OK button:

The **RESET** button deletes the current MIN and MAX values.

The **OK** button is used to confirm the selection in the menu.

6.1.1 Menu for device settings

The device functions "Automatic shut-off", "Units" and "Display filter" are configured in the menu for device settings.

The following illustration shows the procedure for creating the device settings:

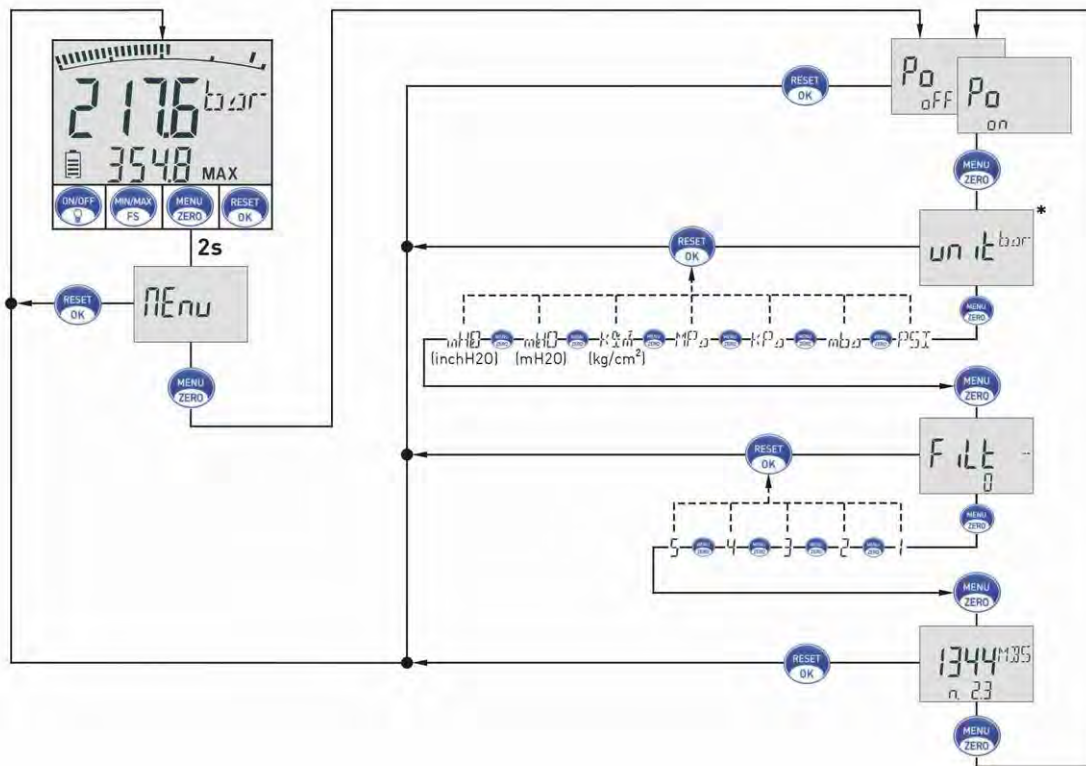

*Unit: The displayed units depend on the pressure range of the device
 (→ "Display resolution" p. 51).

Call the device settings menu with the MENU button.

- ↳ Keep the MENU button pressed for 2 s.
- "Menu" appears in the display.

The individual functions and the possible settings are controlled with the MENU button.

- ↳ Keep pressing the MENU button until the function with the desired setting appears..
- ↳ Press the OK button to save the setting of the function.
- The selection is saved and the device switches back to measuring mode.



IMPORTANT! Automatic return!

If no button is pressed, the device switches back to measuring mode after 10 s.

6.2 Operation of the functions

The operation of the functions in the measuring mode and in the device settings menus are described in the sections below.

Backlight

- ↵ Press and hold the ON/OFF button for 2 s.
 - The display lighting switches on.
 - After 20 s, the lighting automatically switches off.

FS (Full Scale) display

The display of the end scale value (FS) is used to improve the legibility of the bar graph display. The end scale value of the pressure range is displayed numerically in the status bar.

- ↵ Press the MIN/MAX/FS button to switch between the MIN-, MAX- and FS display.
 - The status bar shows MIN, MAX and FS with the related values one after the other.

MIN/MAX display

The MIN/MAX function is used to measure pressure peaks. The MIN/MAX memory always has the lowest (MIN) and highest (MAX) measurement values respectively.

- ↵ Press the MIN/MAX/FS button to switch between the MIN-, MAX- and FS display.
 - The status bar shows MIN, MAX and FS with the related values one after the other.

The MIN/MAX memory is erased when switched off. If you want to perform various pressure tests consecutively, you must erase the MIN/MAX memory after each measurement.

Erasing the MIN/MAX values

- ↵ Press the RESET/OK button to erase the MIN/MAX values and the bar graph display drag indicator.
 - The MIN/MAX values are set to the current measurement value.

Out of pressure range / "oFL" display:

The "oFL" display appears when the current pressure lies outside of the pressure range ($\geq 110\%$ FS) of the E2 / D2 / C2. If the pressure falls below that, the current measurement value is displayed.

The MAX value continues to display "oFL" and must first be reset.

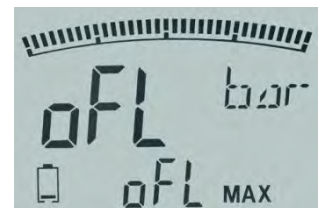

If the "oFL" display is shown in the pressure less state, there is a malfunction.

- ↵ Please contact SIKA.

Zero point correction (ZERO) 

If there are undesired deviations in the pressure less state (atmospheric pressure), the zero point can be manually corrected.

CAUTION! Faulty measurements!

The zero point correction sets the current ACTUAL value to zero. If the ZERO function is activated when pressure is applied, the pressure measurement is no longer made against the ambient pressure, resulting in faulty measurements.

↪ Activate the ZERO function only in the pressure less state.

↪ Press the MENU/ZERO button.

➤ "ZEro on" appears in the display for 2 s. The ZERO function can be activated.

↪ Press the RESET/OK button to do the zero point correction.



➤ The display and the MIN/MAX values are zeroed.

or

➤ "oFL ZEro" appears in the display for 2 s. The measured pressure (0 bar) is greater than 5% of the pressure range. The ZERO function cannot be performed.

➤ The device switches back to measurement mode.

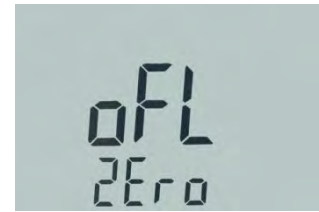
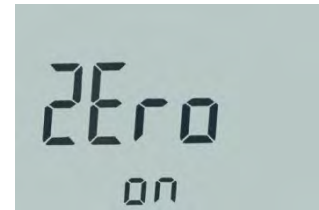
↪ Create a pressure less state and press the MENU/ZERO button again.

**Resetting the zero point correction** 

The zero point correction stays activated until the device is switched off. After it is switched on again, the zero point correction is no longer activated.

6.3 Functions in the menu for device settings

The following functions can be changed in the "Menu for device settings" (→ § 6.1.1).

- ↵ To do this, keep the MENU button pressed for 2 s.
 - The display shows "Menu".
- ↵ Keep pressing the MENU button until the desired function appears.

Automatic shut-off:

Automatic shut-off is used to extend the battery life.

When the function is activated, the device automatically switches off after 5 minutes. If the function is deactivated, the device is in continuous duty and has to be manually switched off with the ON/OFF button.

The current setting is displayed when the device E2 / D2 / C2 is switched on:

- "Po on" = activated (automatic shut-off);
"Po off" = deactivated (continuous duty).
- ↵ Press the MENU button again.
 - The new value of the function is displayed. If the function is already activated "Po off" appears, otherwise "Po on".
- ↵ Press the OK button to save the new value.
 - The selection is saved and the device switches back to measuring mode.



IMPORTANT! The settings are retained after shut-off!

The settings "Po on" or "Po off" are retained and are re-activated when the device is switched on.

Change units:

With the menu item "Unit", you can specify the physical unit of pressure.

- ↵ Keep pressing the MENU button until the menu item "Unit" appears.
 - "Unit" and the first adjustable unit appears (bar).
Pressing the MENU button again shows the next adjustable unit.
Selectable units:
bar, PSI, mbar, kPa, MPa, kg/cm², mH₂O, inchH₂O (depending on the pressure range of the device).
- ↵ Select the desired unit with the MENU button and save your selection with the OK button.
 - The selection is saved and the device switches to measuring mode.

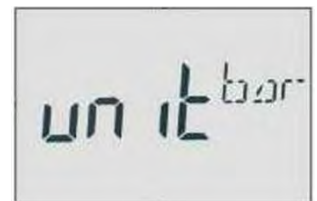

Filter setting (damping):

The menu item "Filt" is used to dampen the display.

- ↪ Keep pressing the MENU button until the menu item "Filt" appears.
 - "Filt 0" appears and right of it the current value (--).
Value selection: 0...7 (0 = no damping).
- ↪ Select the desired value with the MENU button and save your selection with the OK button.
 - The selection is saved and the device switches back to measuring mode.

**Displaying the serial number:**

The menu item shows the serial number and the software version of the device. You need this information for questions if servicing work is required.

Furthermore, you can use this item to exit the "Menu for device settings" without making any changes.

- ↪ Keep pressing the MENU button until the menu item appears.
 - The serial number and the software version appear:
 - 1st line: Displays the serial number.
 - 2nd line: Displays the software version.
 - ↪ Press the MENU button to stay in the "Menu for device settings".
- or
- ↪ Press the OK button to return to the measuring mode.



7 Maintenance and cleaning, storage and transport

CAUTION! Material damage and loss of warranty!



If the customer makes changes or intervenes in the device, important parts or components can be damaged.

Such intervention leads to the voiding of any warranty and the manufacturer's responsibility!

↳ Never modify the device or perform any repairs yourself.

Maintenance:

The digital pressure gauge E2 / D2 / C2 is maintenance-free and cannot be repaired by the user. In case of a defect, the device must be replaced or returned to the manufacturer for repair.

The only thing that needs to be regularly replaced is the batteries. We recommend replacing them with new ones latest after 1.5 years (→ "replacing the batteries").

Cleaning:

Clean the E2 / D2 / C2 with a dry or slightly damp lint-free cloth. Do not use sharp objects or aggressive agents for cleaning.

Storage, transport:

PROCEED CAUTIOUSLY! Electronic Component!



The device contains sensitive electronic components.

↳ Use the original packaging or comparable for transport or shipping.

↳ Avoid shocks and strong vibration.

↳ Protect the device against humidity.



IMPORTANT! Remove the batteries!

If the device will not be used for longer periods, the batteries should be removed from the device to preclude any leaking damage.

7.1 Return shipment to the manufacturer

Due to legal requirements placed on environmental protection and occupational safety and health and to maintain the health and safety of our employees, all units returned to SIKA for repair must be free of toxins and hazardous substances. That also applies to cavities in the devices. If necessary, the customer must neutralise or purge the unit before return to SIKA.

Costs incurred due to inadequate cleaning of the device and possible costs for disposal and/or personal injuries will be billed to the operating company.

WARNING! Risk of injury due to insufficient cleaning!



The operating company is responsible for all damages and harm of any kind, in particular physical injuries (e.g. caustic burns or toxic contaminations), decontamination measures, disposal etc. that can be attributed to insufficient cleaning of the measuring instrument.

☞ Comply with the instructions below before returning the unit.

The following measures must be taken before you send the unit to SIKA for repair:

- ☞ Clean the device thoroughly. This is of extreme importance if the medium is hazardous to health, i.e. caustic, toxic, carcinogenic or radioactive etc.
- ☞ Remove all residues of the media and pay special attention to sealing grooves and slits.
- ☞ Attach a note describing the malfunction, state the application field and the chemical/physical properties of the media.
- ☞ Please follow the instructions on the procedure for sending returns which are on our website (www.sika.net/en/services/return-of-products-rma.html) and please specify a point of contact in case our service department has any questions.

The customer must confirm that the measures were taken by filling out the declaration of decontamination. It can be found on our website as a download:

www.sika.net/images/RMA/Form_return_of_products.pdf

8 Disassembly and disposal



CAUTION! Risk of injury!

Never remove the device from a plant in operation.

↳ Make sure that the plant is shut down professionally.

Before disassembly:

Prior to disassembly, ensure that the equipment

- is switched off.
- is in a safe and de-energised state.
- is depressurised and has cooled down.

Disassembly:

- ↳ Watch out for any leaking media. Take appropriate precautions to collect them.
- ↳ Loosen the pressure connection shank with an open-end wrench (AF 27).
- ↳ Manually turn the E2 / D2 / C2 out of the measurement setup.

Disposal:

In conformance with the 2011/65/EU (RoHS) and 2012/19/EU (WEEE)* directives, the device must be disposed of as electrical and electronic waste.

Observe the legal regulations of the country in which the device is marketed.



NO HOUSEHOLD WASTE!

The E2 / D2 / C2 consists of various different materials. It must not be disposed of with household waste.

↳ Take the E2 / D2 / C2 to your local recycling plant

or

↳ send the E2 / D2 / C2 back to your supplier or to SIKA.

* WEEE reg. no.: DE 25976360

9 Technical data

The technical data of customised versions may differ from the data in these instructions. Please observe the information specified on the type plate.

Characteristics Reference E2 / D2 / C2	
Pressure ranges input - Piezzo resistive pressure cell - Strain gauge pressure cell	-1...3/5/10 bar and -1...20 bar (D2 / C2) -1...20 bar (E2), -1...40/60 bar and 0...100/160/250/400/700/1000 bar
Accuracy (25°C) - Type E2 - Type D2 - Type C2	0.5 % FS ±1 digit 0.1 % FS ±1 digit 0.05 % FS ±1 digit
Sampling rate	10 ms
Internal resolution AD converter	12 bit = 4,096 steps
Temperature influence	0.05% FS / 10 K
Display/ LC Display: - Actual value - MIN/MAX or Full Scale(FS) - Bar graph • Sampling rate - Backlight	4 ½ digits (15 mm) 4 ½ digits (8 mm) 33 segments (drag indicator function) 50 ms (20 measurements /s) 50 x 34 mm
Pressure units	bar, PSI, mbar, kPa, MPa, kg/cm ² , mH2O, inchH2O
Electrical characteristics	
Supply voltage	Battery 2 x1.5 VDC AA (LR6 -AA), Alkaline (Mignon)
Battery life	1,500 hrs (without lighting)
Degree of protection (EN 60529)	IP 67
Ambient conditions and process variables	
Operating temperature	0...50 °C
Fluid temperature	-20...+80 °C
Storage temperature	-20...+60 °C
Relative humidity	< 85%
Vibration	IEC 60068-2-6 / 10...500 Hz / 5 g
Shock	IEC 60068-2-29 / 11 ms / 25 g
Pressure connection: - Material - Connection thread - Gasket	Stainless steel 1.4404 ¼" BSPP (ISO 1179-2) NBR
Housing: - Material - Dimensions	Zinc cast (Rubber protection cap: TPE) Ø = 79 mm, T = 33 mm
Weight	540 g

Display resolution				
Pressure range	bar	PSI	mbar	kPa
-1...3 bar	-.999...3.000	-9.99...43.51	-999...3000	-99.9...300.0
-1...5 bar	-.999...5.000	-9.99...72.52	-999...5000	-99.9...500.0
-1...10 bar	-.999...10.000	-9.99...145.04	-999...10000	-99.9...1000.0
-1...20 bar	-.999...19.999	-14.5...290.1	-999...19999	-99.9...1999.9
-1...40 bar	-1.00...40.00	-14.5...580.2	-/-	-100...4000
-1...60 bar	-1.00...60.00	-14.5...870.2	-/-	-100...6000
0...100 bar	0.00...100.00	0...1450.4	-/-	0...10000
0...160 bar	0.00...160.00	0...2321	-/-	0...16000
0...250 bar	0.00...250.0	0...3626	-/-	-/-
0...400 bar	0.0...400.0	0...5802	-/-	-/-
0...700 bar	0.0...700.0	0...10153	-/-	-/-
0...1000 bar	0.0...1000.0	0...14504	-/-	-/-
Pressure range	MPa	kg/cm2	mH2O	inH2O
-1...3 bar	-.100...0.300	-.999...3.059	-9.99...30.59	-99.9...1204.4
-1...5 bar	-.100...0.500	-.999...5.099	-9.99...50.99	-99.9...1999.9
-1...10 bar	-.100...1.000	-.999...10.197	-9.99...101.97	-401...4015
-1...20 bar	-.100...2.000	-.999...19.999	-9.99...199.99	-401...8029
-1...40 bar	-.100...4.000	-1.02...40.79	-10.2...407.9	-401...16059
-1...60 bar	-.100...6.000	-1.02...61.18	-10.2...611.9	-/-
0...100 bar	0.000...10.000	0.00...101.97	0.0...1019.7	-/-
0...160 bar	0.000...16.000	0.00...163.15	0.0...1631.6	-/-
0...250 bar	0.000...25.00	0.0...254.9	0...2549	-/-
0...400 bar	0.000...40.00	0.0...407.9	0...4079	-/-
0...700 bar	0.000...70.00	0.0...713.8	0...7138	-/-
0...1000 bar	0.000...100.00	0.0...1019.7	0...10197	-/-

CAUTION! Material damage!

Exceeding the maximum overload values (Pmax) can lead to malfunctions and result in the digital manometer being destroyed.

Overload values		
Pressure range	Overload	Burst pressure
-1...3 bar	12 bar	20 bar
-1...5 bar	18 bar	30 bar
-1...10 bar	30 bar	50 bar
-1...20 bar	50 bar (E2) 48 bar (D2 / C2)	250 bar (E2) 80 bar (D2 / C2)
-1...40 bar	80 bar	400 bar
-1...60 bar	120 bar	550 bar
0...100 bar	200 bar	800 bar
0...160 bar	320 bar	1000 bar
0...250 bar	500 bar	1200 bar
0...400 bar	800 bar	1700 bar
0...700 bar	1200 bar	2400 bar
0...1000 bar	1500 bar	2500 bar

Threshold values	Type E2		Type D2 / C2	
	Threshold value [bar]	Resolution [bar]	Threshold value [bar]	Resolution [bar]
-1...3 bar	0.006	0.002	0.003	0.002
-1...5 bar	0.010	0.002	0.005	0.002
-1...10 bar	0.020	0.003	0.01	0.003
-1...20 bar	0.04	0.01	0.02	0.01
-1...40 bar	0.08	0.01	0.04	0.01
-1...60 bar	0.12	0.02	0.06	0.02
0...100 bar	0.20	0.03	0.1	0.03
0...160 bar	0.32	0.04	0.16	0.04
0...250 bar	0.5	0.1	0.3	0.1
0...400 bar	0.8	0.1	0.4	0.1
0...700 bar	1.4	0.2	0.7	0.2
0...1000 bar	2.0	0.3	0.5	0.3

10 EC Declaration of Conformity



EU- Konformitätserklärung EU Declaration of Conformity

Wir erklären, dass die Produkte
We declare that the products

Digitalmanometer
Digital Pressure Manometer

der Baureihe
series

E2

in Verkehr gebracht von
placed on the market by

SIKA Dr. Siebert & Kühn GmbH & Co. KG

übereinstimmen mit
comply with

EMV- RL 2014/30/EU

Richtlinie 2014/30/EU des Europäischen Parlaments und des Rates vom 26. Februar 2014 zur Harmonisierung der Rechtsvorschriften der Mitgliedstaaten über die elektromagnetische Verträglichkeit
Directive 2014/30/EU of the European Parliament and of the Council of 26 February 2014 on the harmonisation of the laws of the Member States relating to electromagnetic compatibility

EMC directive

DGRL 2014/68/EU

Richtlinie 2014/68/EU des Europäischen Parlaments und des Rates vom 15. Mai 2014 zur Harmonisierung der Rechtsvorschriften der Mitgliedstaaten über die Bereitstellung von Druckgeräten auf dem Markt

PED directive

Directive 2014/68/EU of the European Parliament and of the Council of 15 May 2014 on the harmonisation of the laws of the Member States relating to the making available on the market of pressure equipment

RoHS 2011/65/EU

Richtlinie 2011/65/EU des Europäischen Parlaments und des Rates vom 8. Juni 2011 zur Beschränkung der Verwendung bestimmter gefährlicher Stoffe in Elektro- und Elektronikgeräten

RoHS directive

Directive 2011/65/EU of the European Parliament and of the Council of 8 June 2011 on the restriction of the use of certain hazardous substances in electrical and electronic equipment

Die Geräte entsprechen folgenden technischen Vorschriften

The devices comply with following technical specifications

DIN EN 61000-6-2 +
Berichtigung 1:2011

EMV Fachgrundnorm – Störfestigkeit für Industriebereiche

Generic Standard- Immunity for industrial environments

DIN EN 61000-6-3:2007
+ Berichtigung 1:2011

Störaussendung für Wohnbereich, Geschäfts- und Gewerbebereiche sowie Kleinbetriebe

Generic standards - Emission standard for residential, commercial and light-industrial environments

DIN EN 50581:2013

Technische Dokumentation zur Beurteilung von Elektro- und Elektronikgeräten hinsichtlich der Beschränkung gefährlicher Stoffe; Deutsche Fassung EN 50581:2012

Technical documentation for the assessment of electrical and electronic products with respect to the restriction of hazardous substances; German version EN 50581:2012

Kaufungen, den 12. September 2017

i.V.

Dipl.- Ing. K. Ulloth
(CE- Koordinator und Produktsicherheitsbeauftragter)
(Manager CE- Coordination and Safety Supervisor)



EU- Konformitätserklärung
EU Declaration of Conformity

Wir erklären, dass die Produkte
We declare that the products

Digitalmanometer
Digital Pressure Manometer

der Baureihe
series

D2

in Verkehr gebracht von
placed on the market by

SIKA Dr. Siebert & Kühn GmbH & Co. KG

übereinstimmen mit
comply with

EMV- RL 2014/30/EU

Richtlinie 2014/30/EU des Europäischen Parlaments und des Rates vom 26. Februar 2014 zur Harmonisierung der Rechtsvorschriften der Mitgliedstaaten über die elektromagnetische Verträglichkeit
Directive 2014/30/EU of the European Parliament and of the Council of 26 February 2014 on the harmonisation of the laws of the Member States relating to electromagnetic compatibility

EMC directive

DGRL 2014/68/EU

Richtlinie 2014/68/EU des Europäischen Parlaments und des Rates vom 15. Mai 2014 zur Harmonisierung der Rechtsvorschriften der Mitgliedstaaten über die Bereitstellung von Druckgeräten auf dem Markt
Directive 2014/68/EU of the European Parliament and of the Council of 15 May 2014 on the harmonisation of the laws of the Member States relating to the making available on the market of pressure equipment

PED directive

RoHS 2011/65/EU

Richtlinie 2011/65/EU des Europäischen Parlaments und des Rates vom 8. Juni 2011 zur Beschränkung der Verwendung bestimmter gefährlicher Stoffe in Elektro- und Elektronikgeräten
Directive 2011/65/EU of the European Parliament and of the Council of 8 June 2011 on the restriction of the use of certain hazardous substances in electrical and electronic equipment

RoHS directive

Die Geräte entsprechen folgenden technischen Vorschriften
The devices comply with following technical specifications

DIN EN 61000-6-2 +
 Berichtigung 1:2011

EMV Fachgrundnorm – Störfestigkeit für Industriebereiche
Generic Standard- Immunity for industrial environments

DIN EN 61000-6-3:2007
 + Berichtigung 1:2011

Störaussendung für Wohnbereich, Geschäfts- und Gewerbebereiche sowie Kleinbetriebe
Generic standards - Emission standard for residential, commercial and light-industrial environments

DIN EN 50581:2013

Technische Dokumentation zur Beurteilung von Elektro- und Elektronikgeräten hinsichtlich der Beschränkung gefährlicher Stoffe; Deutsche Fassung EN 50581:2012
Technical documentation for the assessment of electrical and electronic products with respect to the restriction of hazardous substances; German version EN 50581:2012

Kaufungen, den 12. September 2017

i.V.

Dipl.- Ing. K. Ulloth
 (CE- Koordinator und Produktsicherheitsbeauftragter)
 (Manager CE- Coordination and Safety Supervisor)



EU- Konformitätserklärung

EU Declaration of Conformity

Wir erklären, dass die Produkte
We declare that the products

Digitalmanometer
Digital Pressure Manometer

der Baureihe
series

C2

in Verkehr gebracht von
placed on the market by

SIKA Dr. Siebert & Kühn GmbH & Co. KG

übereinstimmen mit
comply with

EMV- RL 2014/30/EU

Richtlinie 2014/30/EU des Europäischen Parlaments und des Rates vom 26. Februar 2014 zur Harmonisierung der Rechtsvorschriften der Mitgliedstaaten über die elektromagnetische Verträglichkeit
Directive 2014/30/EU of the European Parliament and of the Council of 26 February 2014 on the harmonisation of the laws of the Member States relating to electromagnetic compatibility

EMC directive

DGRL 2014/68/EU

Richtlinie 2014/68/EU des Europäischen Parlaments und des Rates vom 15. Mai 2014 zur Harmonisierung der Rechtsvorschriften der Mitgliedstaaten über die Bereitstellung von Druckgeräten auf dem Markt

PED directive

Directive 2014/68/EU of the European Parliament and of the Council of 15 May 2014 on the harmonisation of the laws of the Member States relating to the making available on the market of pressure equipment

RoHS 2011/65/EU

Richtlinie 2011/65/EU des Europäischen Parlaments und des Rates vom 8. Juni 2011 zur Beschränkung der Verwendung bestimmter gefährlicher Stoffe in Elektro- und Elektronikgeräten

RoHS directive

Directive 2011/65/EU of the European Parliament and of the Council of 8 June 2011 on the restriction of the use of certain hazardous substances in electrical and electronic equipment

Die Geräte entsprechen folgenden technischen Vorschriften
The devices comply with following technical specifications

DIN EN 61000-6-2 +
Berichtigung 1:2011

EMV Fachgrundnorm – Störfestigkeit für Industriebereiche
Generic Standard- Immunity for industrial environments

DIN EN 61000-6-3:2007
+ Berichtigung 1:2011

Störaussendung für Wohnbereich, Geschäfts- und Gewerbebereiche sowie Kleinbetriebe
Generic standards - Emission standard for residential, commercial and light-industrial environments

DIN EN 50581:2013

Technische Dokumentation zur Beurteilung von Elektro- und Elektronikgeräten hinsichtlich der Beschränkung gefährlicher Stoffe; Deutsche Fassung EN 50581:2012
Technical documentation for the assessment of electrical and electronic products with respect to the restriction of hazardous substances; German version EN 50581:2012

Kaufungen, den 12. September 2017

i.V.

Dipl.- Ing. K. Ulloth
(CE- Koordinator und Produktsicherheitsbeauftragter)
(*Manager CE- Coordination and Safety Supervisor*)

SIKA Dr. Siebert & Kühn GmbH & Co. KG · Struthweg 7-9 · D-34260 Kaufungen · Tel. +49 (0) 5605/803-0 · Fax +49 (0) 5605/803-54 · info@sika.net · www.sika.net

CE_C2_D914.doc