

Actuators

ISO/VDMA Profile cylinders

PRA/182000, PRA/182000/M

Double acting

Ø 32 to 125 mm

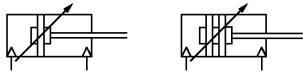

Conforms to ISO 6431, VDMA 24562 and NFE 49-003-1

Profile barrel with concealed tie rods

High performance, stability and reliability

Polyurethane seals ensure efficient low friction operation and long life

Switches can be mounted flush with the profile barrel

Comprehensive range of standard mountings

Technical data

Medium:

Compressed air, filtered, lubricated or non-lubricated

Operation:

PRA/182000: Adjustable cushioning

PRA/182000/M: Magnetic piston, adjustable cushioning

Operating pressure: 1 to 16 bar

Operating temperature: -20°C to +80°C max.

High temperature versions: 150°C max.

Consult our Technical Service for use below +2°C

Strokes:

Standard: see next page

Non-standard strokes available (10 to 3000 mm)

Materials

Profile barrel: anodised aluminium

End covers: pressure diecast aluminium

Piston rod: stainless steel (Martensitic)

Piston rod seals: polyurethane

Piston seals: polyurethane

O-rings: nitrile rubber

Standard models

Ø	Piston rod Ø	Port size	Model (Magnetic)		Model (Non-magnetic)		Service kit	
			Standard	Non-rotating	Standard	Non-rotating	Standard	Non-rotating
32	12	G1/8	PRA/182032/M/*	PRA/182032/N2/*	PRA/182032/*	PRA/182032/N1/*	QA/8032/00	QA/8032/N1/00
40	16	G1/4	PRA/182040/M/*	PRA/182040/N2/*	PRA/182040/*	PRA/182040/N1/*	QA/8040/00	QA/8040/N1/00
50	20	G1/4	PRA/182050/M/*	PRA/182050/N2/*	PRA/182050/*	PRA/182050/N1/*	QA/8050/00	QA/8050/N1/00
63	20	G3/8	PRA/182063/M/*	PRA/182063/N2/*	PRA/182063/*	PRA/182063/N1/*	QA/8063/00	QA/8063/N1/00
80	25	G3/8	PRA/182080/M/*	PRA/182080/N2/*	PRA/182080/*	PRA/182080/N1/*	QA/8080/00	QA/8080/N1/00
100	25	G1/2	PRA/182100/M/*	PRA/182100/N2/*	PRA/182100/*	PRA/182100/N1/*	QA/8100/00	QA/8100/N1/00
125	32	G1/2	PRA/182125/M/*	-	PRA/182125/*	-	QA/8125/00	-

*Insert stroke length in mm.

Options selector

★ P ★ A / 182 ★ ★ ★ / ★ ★ / ★ ★ ★ ★

Special variants	Substitute	←	Strokes (mm)	3000 max.
Heat resistant seals, 150°C max.	T			Variants (non-magnetic piston)
Hydraulic	H	Standard	None	
Piston rod material	Substitute	←	Special wiper/seal	W1
Stainless steel (Martensitic)	R		Low friction	X1
Hard chromium plated	C	←	Piston rod bellow	G
Stainless steel (Austenitic)	S		Without cushioning	W
Cylinder diameters (mm)	Substitute	←	Without cushioning, low friction	X3
032, 040, 050, 063, 080, 100, 125			Double ended piston rod	J
Variants (magnetic piston)	Substitute	←	Double ended piston rod, special wiper/seal	W3
Standard	M		Four-position	IT
Special wiper/seal	W2	←	Non-rotating piston rod	N1
Low friction	X2		Locking unit	L2
Piston rod bellow	MG	←	Barrel turned at 90° for use with guide blocks QA/8000/61/*	IIL
Without cushioning	MW		Feedback	F1
Without cushioning, low friction	X4	←	Extended piston rod	IU
Double ended piston rod	JM		Extended piston rod, special wiper/seal	W5
Double ended piston rod & special wiper/seal	W4	←	P*A/182***/IU/****/***/W5/ Extension (mm)	
Four-position	MT			
Non-rotating piston rod	N2	←		
Locking unit	L4			
Barrel turned at 90° for use with guide blocks	MIL	←		
Extended piston rod	MU			
Extended piston rod & special wiper/seal	W6	←		

Note: Disregard option positions not used. For combinations of cylinder variants consult our Technical Service.

Switches



	Model	Plug-in cable	Groove cover
Reed	M/50/LSU/*V	M/50/LSU/CP	M/P73001/5 (5 m)
Solid state	M/50/EAP/*V	M/50/EAP/CP	M/P73001/5 (5 m)

*Insert cable length – 2, 5 or 10 m. For details see page 198

ISO/VDMA Profile cylinders

PRA/182000, PRA/182000/M

Double acting

Ø 32 to 125 mm

Standard strokes

Ø	25	50	80	100	125	160	200	250	320	400	500
32	●	●	●	●	●	●	●	●	○	○	○
40	●	●	●	●	●	●	●	●	●	○	○
50	●	●	●	●	●	●	●	●	●	○	○
63	●	●	●	●	●	●	●	●	●	○	○
80	●	●	●	●	●	●	●	●	●	○	○
100	●	●	●	●	●	●	●	●	●	○	○
125	○	○	○	○	○	○	○	○	○	○	○

● Indicates stocked stroke lengths of standard models highlighted in table.

Ø	Theoretical forces (N) at 6 bar	
	Outstroke	Instroke
32	482	414
40	754	633
50	1178	990
63	1870	1680
80	3016	2722
100	4710	4416
125	7363	6882

Cylinder sizing and speed control see page 6

Mountings

Ø	A	AK	B, G	C	D	D2	F	FH	L
32	QM/8032/35	QM/8025/38	QA/8032/22	QA/8032/21	QA/8032/23	QA/8032/42	QM/8025/25	QA/8032/34	QA/8032/24
40	QM/8032/35	QM/8040/38	QA/8040/22	QA/8040/21	QA/8040/23	QA/8040/42	QM/8040/25	QA/8040/34	QA/8040/24
50	QM/8050/35	QM/8050/38	QA/8050/22	QA/8050/21	QA/8050/23	QA/8050/42	QM/8050/25	QA/8050/34	QA/8050/24
63	QM/8050/35	QM/8050/38	QA/8063/22	QA/8063/21	QA/8063/23	QA/8063/42	QM/8050/25	QA/8063/34	QA/8063/24
80	QM/8080/35	QM/8080/38	QA/8080/22	QA/8080/21	QA/8080/23	QA/8080/42	QM/8080/25	QA/8080/34	QA/8080/24
100	QM/8080/35	QM/8080/38	QA/8100/22	QA/8100/21	QA/8100/23	QA/8100/42	QM/8080/25	QA/8100/34	QA/8100/24
125	QM/8125/35	QM/8125/38	QA/8125/22	QA/8125/21	QA/8125/23	QA/8125/42	QM/8125/25	QA/8125/34	QA/8125/24
Ø	M	R	S	SS	SW	UF	UH	UL	UR
32	QM/8032/26	QA/8032/27	QA/8032/41	M/P19931	M/P19493	QM/8025/32	PQA/182032/40	QA/8032/43	QA/8032/33
40	QM/8040/26	QA/8040/27	QA/8040/41	M/P19932	M/P19494	QM/8040/32	PQA/182040/40	QA/8040/43	QA/8040/33
50	QM/8050/26	QA/8050/27	QA/8040/41	M/P19933	M/P19495	QM/8050/32	PQA/182050/40	QA/8050/43	QA/8050/33
63	QM/8063/26	QA/8063/27	QA/8063/41	M/P19934	M/P19496	QM/8050/32	PQA/182063/40	QA/8063/43	QA/8063/33
80	QM/8080/26	QA/8080/27	QA/8063/41	M/P19935	M/P19497	QM/8080/32	PQA/182080/40	QA/8080/43	QA/8080/33
100	QM/8100/26	QA/8100/27	QA/8100/41	M/P19936	M/P19498	QM/8080/32	PQA/182100/40	QA/8100/43	QA/8100/33
125	QM/8125/26	QA/8125/27	QA/8100/41	M/P19937	M/P19499	QM/8125/32	PQA/182125/40	QA/8125/43	QA/8125/33
Ø	US	Guide block*	Guide block*	Guide block *	Guide block*	Locking units (passive)	Groove key		
32	M/P40310	QA/8032/51/*	QA/8032/61/*	QA/8032/*/81	QA/8032/*/85	QA/8032/59	M/P72816		
40	M/P40311	QA/8040/51/*	QA/8040/61/*	QA/8040/*/81	QA/8040/*/85	QA/8040/59	M/P72816		
50	M/P40312	QA/8050/51/*	QA/8050/61/*	QA/8050/*/81	QA/8050/*/85	QA/8050/59	M/P72816		
63	M/P40313	QA/8063/51/*	QA/8063/61/*	QA/8063/*/81	QA/8063/*/85	QA/8063/59	M/P72816		
80	M/P40314	QA/8080/51/*	QA/8080/61/*	QA/8080/*/81	QA/8080/*/85	QA/8080/59	M/P72816		
100	M/P40315	QA/8100/51/*	QA/8100/61/*	QA/8100/*/81	QA/8100/*/85	QA/8100/59	M/P72816		
125	M/P71355	-	-	-	-	QA/8125/59			

Please see page 76 for details of mountings.

For switches M/50 see page 198.

*Please see page 70 for details of piston rod guide blocks and page 68 for locking units.

ISO/VDMA Profile cylinders

PRA/182000, PRA/182000/M

Double acting

Ø 32 to 125 mm

Standard cylinders

PRA/182000, PRA/182000/M

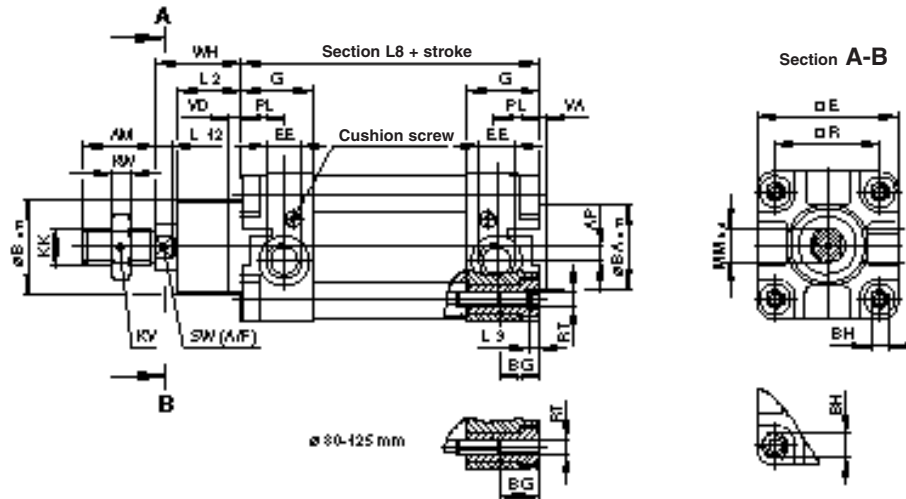

Ø	AM	AP	Ø B e11	Ø BA e11	BG	BH (A/F)	□ E	EE	G	KK	KV (A/F)	KW	L2
32	22	3,5	30	30	18	6	47	G 1/8	27,5	M10 x 1,25	17	5	20
40	24	4,5	35	35	18	6	53	G 1/4	32	M12 x 1,25	19	6	22
50	32	6	40	40	18	8	65	G 1/4	31	M16 x 1,5	24	8	27
63	32	10	45	45	17,5	8	75	G 3/8	33	M16 x 1,5	24	8	29
80	40	8,5	45	45	21,5	19	95	G 3/8	33	M20 x 1,5	30	10	33
100	40	9	55	55	21,5	19	115	G 1/2	37	M20 x 1,5	30	10	36
125	54	10	60	60	32	24	140	G 1/2	46	M27 x 2	41	13,5	41
Ø	L8	L9	L12	Ø MM h9	PL	□ R	RT	SW (A/F)	VA	VD	WH	kg at 0 mm	kg per 25 mm
32	94	4	6	12	13	32,5	M 6	10	3	6	26	0,51	0,06
40	105	4	6,5	16	15	38	M 6	13	3,5	6	30	0,80	0,08
50	106	5	8	20	18,5	46,5	M 8	17	3,5	6	37	1,33	0,12
63	121	5	8	20	19	56,5	M 8	17	4	6	37	1,80	0,13
80	128	–	10	25	19	72	M 10	22	4	6	46	3,25	0,20
100	138	–	10	25	18	89	M 10	22	4	6	51	4,81	0,23
125	160	–	13	32	22,5	110	M 12	27	6	15,5	65	8,00	0,33

ISO/VDMA Profile cylinders

PRA/182000, PRA/182000/M

Double acting

Ø 32 to 125 mm

Cylinder variants

PRA/182000/J, PRA/182000/JM — Cylinders with double ended piston rod

Ø	ZM	L8
32	146	94
40	165	105
50	180	106
63	195	121
80	220	128
100	240	138
125	290	160

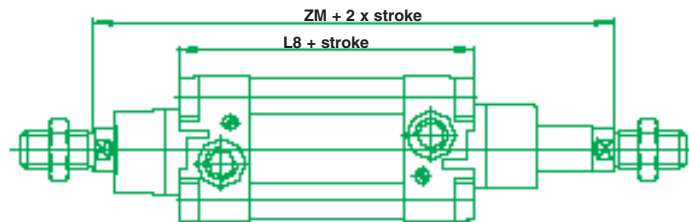

PRA/182000/N1, PRA/182000/N2 — Cylinders with non-rotating piston rod

Ø	SW1 (A/F)
32	10
40	13
50	16
63	16
80	21
100	21

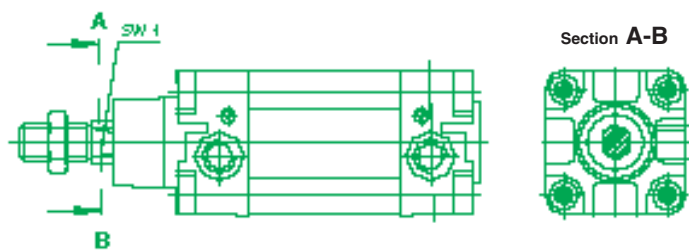

PRA/182000/IT, PRA/182000/MT — Four-position cylinders

Ø	L 8	L 10	L 11
32	94	247	7
40	105	278	8
50	106	294	8
63	121	325	9
80	128	357	9
100	138	387	9
125	160	462	12

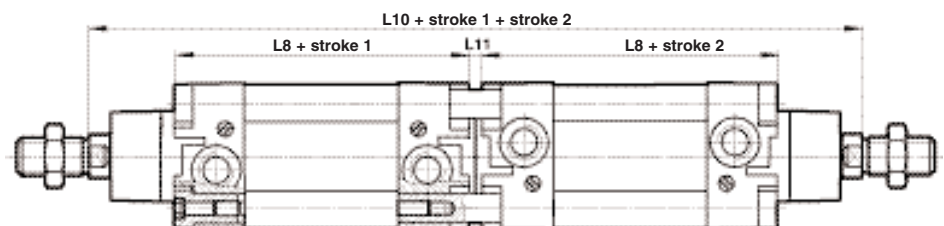

ISO/VDMA Cylinders

RA/8000/M

Double acting

Ø 32 to 320 mm

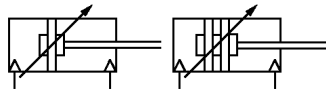
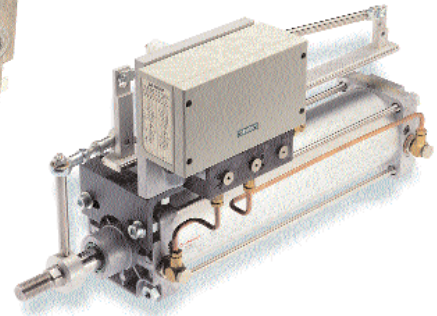
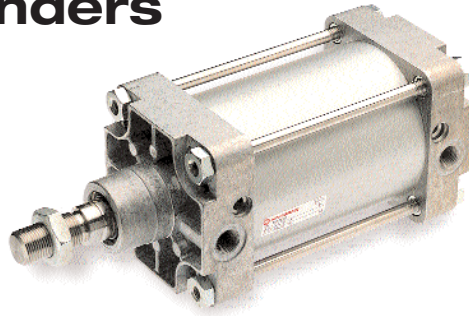

Conforms to ISO 6431, VDMA 24562 and NFE 49-003-1
 High performance, ruggedness and reliability
 Extensive range of mountings

Technical data

Medium:
 Compressed air, filtered, lubricated or non-lubricated
 Standard:
 ISO 6431, VDMA 24562, NFE 49-003-1 and corresponding BS

Operation:
 RA/8000 double acting, adjustable cushioning
 RA/8000/M double acting, magnetic piston, adjustable cushioning

Operating pressure:
 1 to 16 bar (1 to 10 bar for Ø 250 and 320 mm)

Operating temperature:
 -20°C to +80°C max.
 (-10°C to +80°C max. for Ø 125 to 320 mm)

Consult our Technical Service for use below +2°C

Strokes:
 Standard, see table
 Non-standard strokes up to 3000 mm maximum

Materials

Barrel: anodised aluminium
 End covers: pressure diecast aluminium (Ø 200 to 320 mm gravity cast aluminium)
 Piston rod: stainless steel (Martensitic)
 Piston rod seals: polyurethane (Ø 125 to 320 mm nitrile rubber)
 Piston seals: polyurethane (Ø 125 to

Standard models

Ø	Piston rod Ø	Port size	Model		Service kit
			Non-magnetic	Magnetic	
32	12	G1/8	RA/8032/*	RA/8032/M/*	QA/8032/00
40	16	G1/4	RA/8040/*	RA/8040/M/*	QA/8040/00
50	20	G1/4	RA/8050/*	RA/8050/M/*	QA/8050/00
63	20	G3/8	RA/8063/*	RA/8063/M/*	QA/8063/00
80	25	G3/8	RA/8080/*	RA/8080/M/*	QA/8080/00
100	25	G1/2	RA/8100/*	RA/8100/M/*	QA/8100/00
125	32	G1/2	RA/8125/*	RA/8125/M/*	QA/8125/00
160	40	G3/4	RA/8160/*	RA/8160/M/*	QA/8160/00
200	40	G3/4	RA/8200/*	RA/8200/M/*	QA/8200/00
250	50	G1	RA/8250/*	RA/8250/M/*	QA/8250/00
320	63	G1	RA/8320/*	RA/8320/M/*	QA/8320/00

* Insert stroke length in mm. Cylinder sizing and speed control see page 6

Standard strokes

Ø	25	50	80	100	125	160	200	250	320	400	500
32	○	○	○	○	○	○	○	○	○	○	○
40	○	○	○	○	○	○	○	○	○	○	○
50	○	○	○	○	○	○	○	○	○	○	○
63	○	○	○	○	○	○	○	○	○	○	○
80	○	○	○	○	○	○	○	○	○	○	○
100	○	○	○	○	○	○	○	○	○	○	○
125	○	○	○	○	○	○	○	○	○	○	○
160	○	○	○	○	○	○	○	○	○	○	○
200	○	○	○	○	○	○	○	○	○	○	○
250	○	○	○	○	○	○	○	○	○	○	○
320	○	○	○	○	○	○	○	○	○	○	○

Options selector

A/8/**/**/**

Special variants	Substitute	←	→	Strokes (mm)	3000 max.
Heat resistant seals, 150°C max.	T			Variants (non-magnetic piston)	Substitute
Piston rod material	Substitute	←	→	Standard	None
Stainless steel (Martensitic)	R			Special wiper/seal	W1
Hard chromium plated	C	←	→	Low friction	X1
Stainless steel (Austenitic)	S			Piston rod bellow	G
Threads	Substitute	←	→	Without cushioning	W
Metric Ports: ISO 228 (G 1/8 to G 1)	A			Without cushioning, low friction	X3
Series	Substitute	←	→	Double ended piston rod	J
8000	8			Double ended piston rod, special wiper/seal	W3
Cylinder diameters (mm)	Substitute	←	→	Four position	IT
032, 040, 050, 063, 080, 100, 125, 160, 200, 250, 320				Non-rotating piston rod	N1
Variants (magnetic piston)	Substitute	←	→	Locking unit	L2
Standard	M			Cylinder with Foxboro Positioner, left hand#	P1
Special wiper/seal	W2	←	→	Cylinder with Foxboro Positioner, left hand##	P2
Low friction	X2			Cylinder with Foxboro Positioner, right hand#	P3
Piston rod bellow	MG	←	→	Cylinder with Foxboro Positioner, right hand##	P4
Without cushioning	MW			Cylinder with Siemens Positioner, left hand#	P5
Without cushioning, low friction	X4	←	→	Cylinder with Siemens Positioner, left hand##	P6
Double ended piston rod	JM			Cylinder with Siemens Positioner, right hand#	P7
Double ended piston rod, special wiper/seal	W4	←	→	Cylinder with Siemens Positioner, right hand##	P8
Four position	MT			Extended piston rod	IU
				Extended piston rod, special wiper/seal	W5

Note: If option is not required, disregard option position within part number eg. RA/8100/100
 For combinations of cylinder variants consult our Technical Service.

A/8000/IU/**/**/**
 /W5/ → Extension (mm)

Direct acting, ## Reverse acting.

Switches

ISO/VDMA Cylinders

RA/8000/M

Double acting

Ø 32 to 320 mm

Mountings

Ø	A	AK	B, G	C	D	D2	F	FH	H	L
32	QM/8032/35	QM/8025/38	QA/8032/22	QA/8032/21	QA/8032/23	QA/8032/42	QM/8025/25	QA/8032/34	QM/8032/28	QA/8032/24
40	QM/8032/35	QM/8040/38	QA/8040/22	QA/8040/21	QA/8040/23	QA/8040/42	QM/8040/25	QA/8040/34	QM/8040/28	QA/8040/24
50	QM/8050/35	QM/8050/38	QA/8050/22	QA/8050/21	QA/8050/23	QA/8050/42	QM/8050/25	QA/8050/34	QM/8050/28	QA/8050/24
63	QM/8050/35	QM/8050/38	QA/8063/22	QA/8063/21	QA/8063/23	QA/8063/42	QM/8050/25	QA/8063/34	QM/8063/28	QA/8063/24
80	QM/8080/35	QM/8080/38	QA/8080/22	QA/8080/21	QA/8080/23	QA/8080/42	QM/8080/25	QA/8080/34	QM/8080/28	QA/8080/24
100	QM/8080/35	QM/8080/38	QA/8100/22	QA/8100/21	QA/8100/23	QA/8100/42	QM/8080/25	QA/8100/34	QM/8100/28	QA/8100/24
125	QM/8125/35	QM/8125/38	QM/8125/22	QM/8125/21	QM/8125/23	QA/8125/42	QM/8125/25	QA/8125/34	QM/8125/28	QM/8125/24
160	QM/8160/35	QM/8160/38	QM/8160/22	QM/8160/21	QM/8160/23	QA/8160/42	QM/8160/25	-	QM/8160/28	QM/8160/24
200	QM/8160/35	QM/8160/38	QM/8200/22	QM/8200/21	QM/8200/23	QA/8200/42	QM/8160/25	-	QM/8200/28	QM/8200/24
250	QM/8250/35	-	QM/8250/22	QM/8250/21	QM/8250/23	-	QM/8250/25	-	QM/8250/28	QM/8250/24
320	QM/8320/35	-	QM/8320/22	QM/8320/21	QM/8320/23	-	QM/8320/25	-	QM/8320/28	QM/8320/24
Ø	M	R	S	SS	SW	UF	UH	UL	UR	US
32	QM/8032/26	QA/8032/27	QA/8032/41	M/P19931	M/P19493	QM/8025/32	QA/8032/40	QA/8032/43	QA/8032/33	M/P40310
40	QM/8040/26	QA/8040/27	QA/8040/41	M/P19932	M/P19494	QM/8040/32	QA/8040/40	QA/8040/43	QA/8040/33	M/P40311
50	QM/8050/26	QA/8050/27	QA/8040/41	M/P19933	M/P19495	QM/8050/32	QA/8050/40	QA/8050/43	QA/8050/33	M/P40312
63	QM/8063/26	QA/8063/27	QA/8063/41	M/P19934	M/P19496	QM/8050/32	QA/8063/40	QA/8063/43	QA/8063/33	M/P40313
80	QM/8080/26	QA/8080/27	QA/8063/41	M/P19935	M/P19497	QM/8080/32	QA/8080/40	QA/8080/43	QA/8080/33	M/P40314
100	QM/8100/26	QA/8100/27	QA/8100/41	M/P19936	M/P19498	QM/8080/32	QA/8100/40	QA/8100/43	QA/8100/33	M/P40315
12	QM/8125/26	QM/8125/27	QA/8100/41	M/P19937	M/P19499	QM/8125/32	QA/8125/40	QA/8125/43	QM/8125/33	M/P71355
160	QM/8160/26	QM/8160/27	QM/8160/41	M/P19938	M/P19679	QM/8160/32	QA/8160/40	QM/8160/43	QM/8160/33	M/P71356
200	QM/8200/26	QM/8200/27	QM/8160/41	M/P19939	M/P19683	QM/8160/32	QA/8200/40	QM/8200/43	QM/8200/33	M/P71357
250	-	-	-	-	M/P19446	QM/8250/32	-	-	-	-
320	-	-	-	-	M/P19447	QM/8320/32	-	-	-	-
Ø	Guide block	Guide block	Guide block	Guide block	Locking units (passive)	Switch mounting brackets #	Switch mounting brackets ##	Switch mounting brackets ###		
32	QA/8032/51/*	QA/8032/61/*	QA/8032/81/*	QA/8032/85/*	QA/8032/59	QM/27/2/1	QM/31/032/22	QM/140/010/22		
40	QA/8040/51/*	QA/8040/61/*	QA/8040/81/*	QA/8040/85/*	QA/8040/59	QM/27/2/1	QM/31/032/22	QM/140/010/22		
50	QA/8050/51/*	QA/8050/61/*	QA/8050/81/*	QA/8050/85/*	QA/8050/59	QM/27/2/1	QM/31/032/22	QM/140/010/22		
63	QA/8063/51/*	QA/8063/61/*	QA/8063/81/*	QA/8063/85/*	QA/8063/59	QM/27/2/1	QM/31/032/22	QM/140/010/22		
80	QA/8080/51/*	QA/8080/61/*	QA/8080/81/*	QA/8080/85/*	QA/8080/59	QM/27/2/1	QM/31/080/22	QM/140/010/22		
100	QA/8100/51/*	QA/8100/61/*	QA/8100/81/*	QA/8100/85/*	QA/8100/59	QM/27/2/1	QM/31/080/22	QM/140/010/22		
125	-	-	-	-	QA/8125/59	QM/27/2/1	QM/31/080/22	-		
160	-	-	-	-	-	-	QM/31/160/22	-		
200	-	-	-	-	-	-	QM/31/160/22	-		
250	-	-	-	-	-	-	QM/31/250/22	-		
320	-	-	-	-	-	-	QM/31/320/22	-		

Please see page 76 for details of mountings.

*Refer to page 70 for details of piston rod guide blocks and page 68 for locking units. Consult our Technical Service for stroke lengths above 500 mm.

For use with switches M/50, see page 198

For use with switches QM/32 or QM/132 see page 199

For use with Pneumatic switches.

ISO/VDMA Cylinders

RA/8000/M

Double acting

Ø 32 to 320 mm

Standard cylinders

RA/8000, RA/8000/M

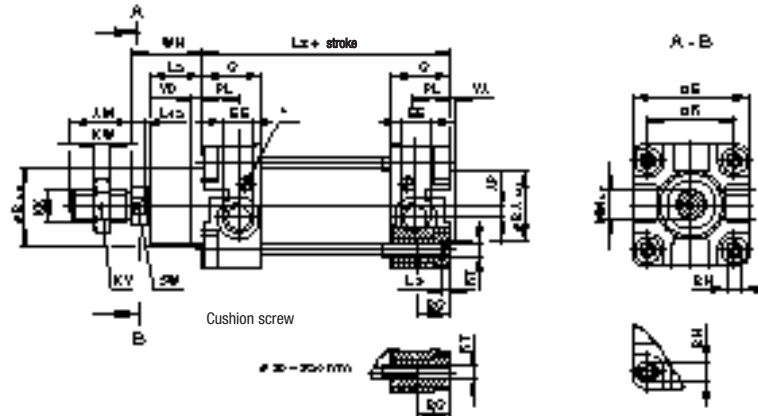

Ø	AM	AP	Ø B e11	Ø BA e11	BG	BH (A/F)	□ E	EE	G	KK	KV (A/F)	KW	L2
32	22	3,5	30	30	18	6	47	G1/8	27,5	M10x1,25	17	5	20
40	24	4,5	35	35	18	6	53	G1/4	32	M12x1,25	19	6	22
50	32	6	40	40	18	8	65	G1/4	31	M16x1,5	24	8	27
63	32	10	45	45	17,5	8	75	G3/8	33	M16x1,5	24	8	29
80	40	8,5	45	45	21,5	19	95	G3/8	33	M20x1,5	30	10	33
100	40	9	55	55	21,5	19	115	G1/2	37	M20x1,5	30	10	36
125	54	10	60	60	32	24	140	G1/2	46	M27x2	41	13,5	45
160	72	18	65	65	28,5	32	183,5	G3/4	50	M36x2	55	18	58
200	72	18	75	75	28,5	32	224	G3/4	50	M36x2	55	18	67
250	84	22,5	90	90	35	36	280	G1	58	M42x2	65	21	80
320	96	22,5	110	110	30	46	350	G1	60	M48x2	75	24	90
Ø	L8	L9	L12	Ø MM h9	PL	□ R	RT	SW (A/F)	VA	VD	WH	kg at 0 mm	kg per 25 mm
32	94	4	6	12	13	32,5	M 6	10	3	6	26	0,51	0,06
40	105	4	6,5	16	15	38	M 6	13	3,5	6	30	0,80	0,08
50	106	5	8	20	18,5	46,5	M 8	17	3,5	6	37	1,33	0,12
63	121	5	8	20	19	56,5	M 8	17	4	6	37	1,80	0,13
80	128	-	10	25	19	72	M 10	22	4	6	46	3,25	0,20
100	138	-	10	25	18	89	M 10	22	4	6	51	4,81	0,23
125	160	-	13	32	20	110	M 12	27	6	15,5	65	8,00	0,33
160	180	-	16	40	21	140	M 16	36	4	15	80	14,9	0,55
200	180	-	16	40	21	175	M 16	36	5	15	95	21,7	0,60
250	200	-	20	50	29	220	M 20	41	7	13	105	32,6	0,92
320	220	-	24	63	30	270	M 24	55	7	13	120	59,8	1,46

Cylinder variants

RA/8000/J, RA/8000/JM – Cylinders with double ended piston rod

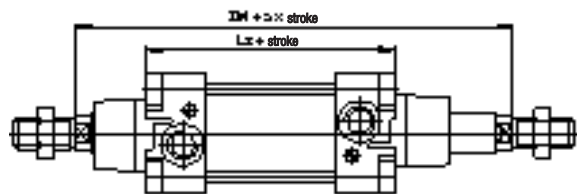

Ø	ZM	L8
32	146	94
40	165	105
50	180	106
63	195	121
80	220	128
100	240	138
125	290	160
160	340	180
200	370	180

RA/8000/N1, RA/8000/N2 – Cylinders with non-rotating piston rod

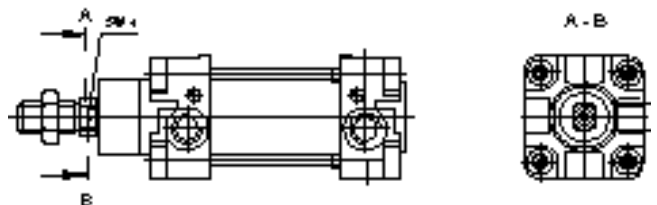

Ø	SW1 (A/F)
32	10
40	13
50	16
63	16
80	21
100	21

ISO/VDMA Cylinders

RA/8000/M

Double acting

Ø 32 to 320 mm

RA/8000/IT, RA/8000/MT – Four position cylinders

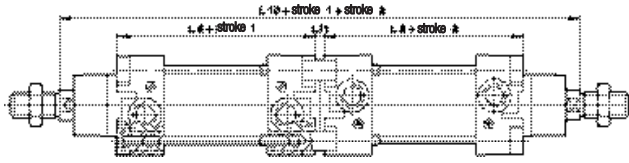

Ø	L 8	L 10	L 11
32	94	247	7
40	105	278	8
50	106	294	8
63	121	325	9
80	128	357	9
100	138	387	9
125	160	462	12
160	180	530	10
200	180	560	10

RA/8000/G, RA/8000/MG – Cylinders with piston rod gaiter

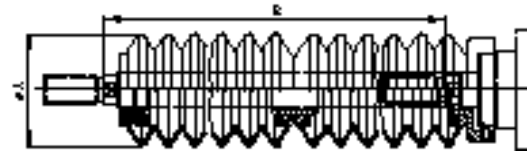

Ø	Ø A	Maximum stroke per gaiter	Piston rod extension B	
			First gaiter	Further gaiter
32	40	60	30	25
40	63	145	50	32
50	63	145	40	32
63	63	145	40	32
80	80	250	50	45
100	80	250	50	45
125	80	250	50	45
160	116	350	70	60
200	116	350	70	60
250	116	350	70	60
320	143	500	110	100

RA/8000/P1 to RA/8000/P8

For cylinders with FOXBORO/ECKARDT or SIEMENS positioner

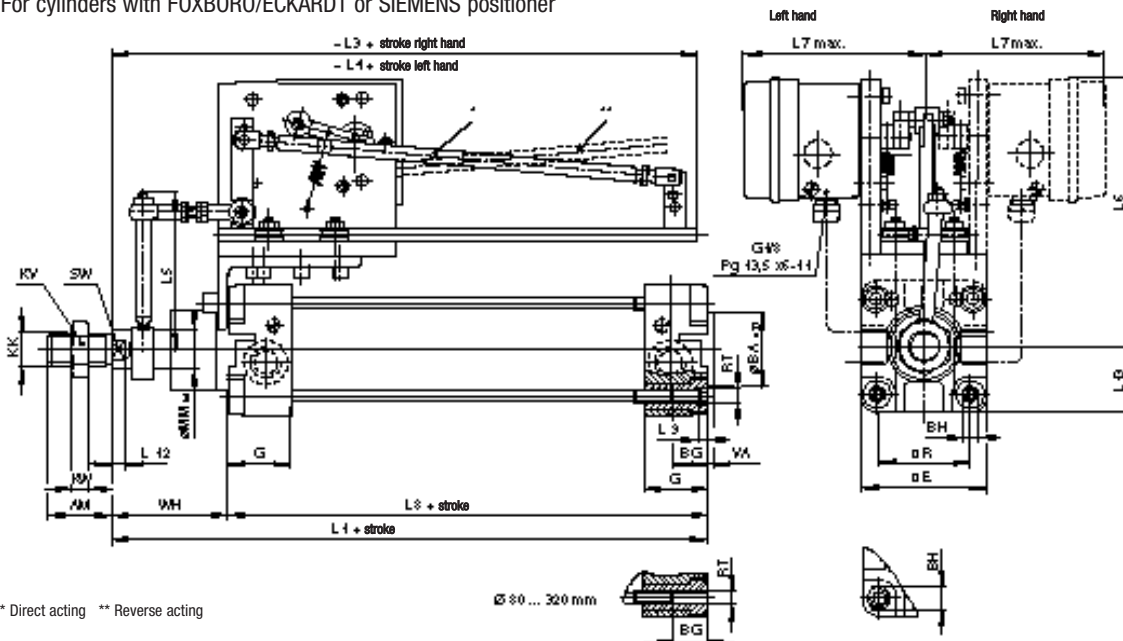

* Direct acting ** Reverse acting

Ø	AM	Ø B ø11	BG	BH (AF)	□ E	G	KK	KV (AF)	KW	L1	L3	L4	
63	32	45	17,5	8	75	33	M 16 x 1,5	24	8	218	235	245	
80	40	45	21,5	19	95	33	M 20 x 1,5	30	10	229	240	250	
100	40	55	21,5	19	115	37	M 20 x 1,5	30	10	239	240	250	
125	54	60	32	24	140	46	M 27 x 2	41	13.5	275	253	263	
160	72	65	28,5	32	180	50	M 36 x 2	55	18	300	258	268	
200	72	75	28,5	32	220	50	M 36 x 2	55	18	310	265	275	
250	84	90	35	36	280	58	M 42 x 2	65	21	365	300	310	
320	96	110	30	46	350	60	M 48 x 2	75	24	380	295	305	
Ø	L5	L6	L7 (max.)	L8	L9	L12	L13	Ø MM h9	□ R	RT	SW (A/F)	VA	WH
63	132,5	232	219	121	5	8	37,5	20	56,5	M 8	17	4	97
80	134,5	239	219	128	–	10	47,5	25	72	M 10	22	4	101
100	144,5	248	219	138	–	10	57,5	25	89	M 10	22	4	101
125	159	262	219	160	–	13	70	32	110	M 12	27	6	115
160	174	277	219	180	–	16	90	40	140	M 16	36	4	120
200	202	305	248	180	–	16	110	40	175	M 16	36	5	130
250	228	327	274	200	–	20	140	50	220	M 20	41	7	165
320	265	357	309	220	–	24	175	63	270	M 24	55	7	160